

1

2

3

4

A

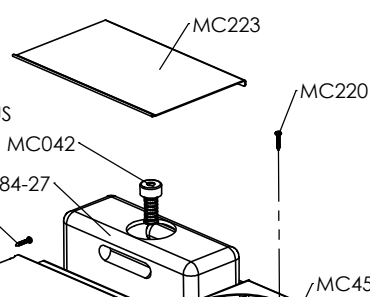
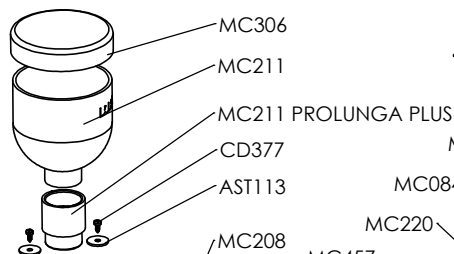
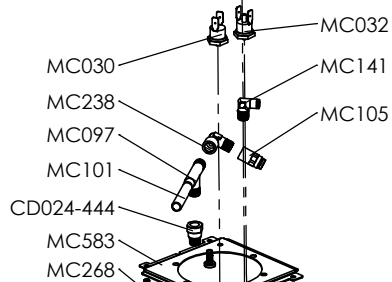
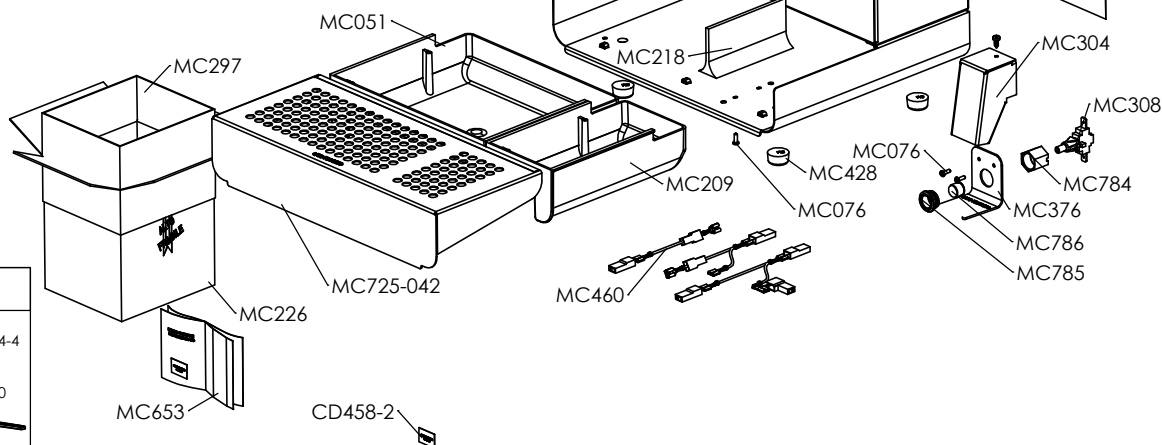
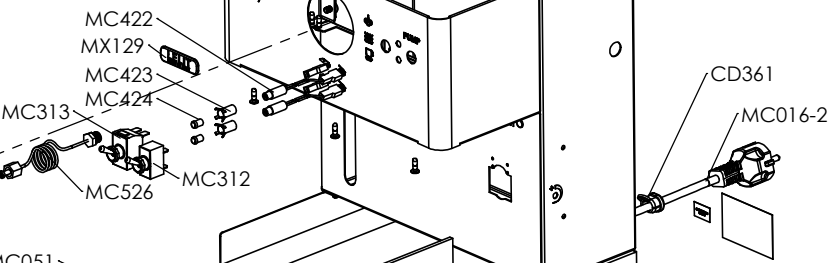
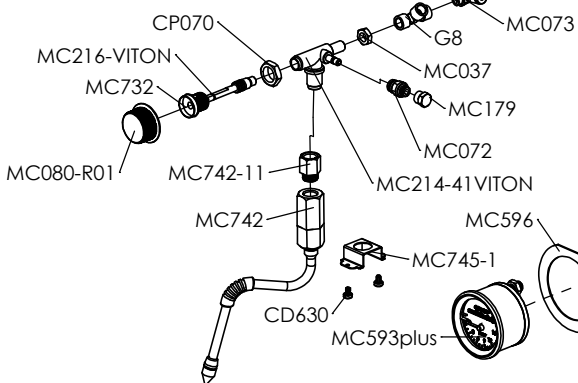
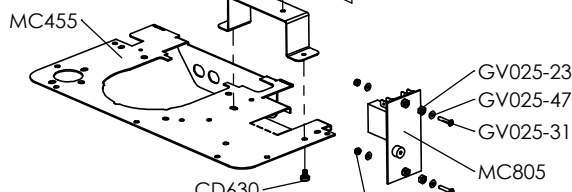
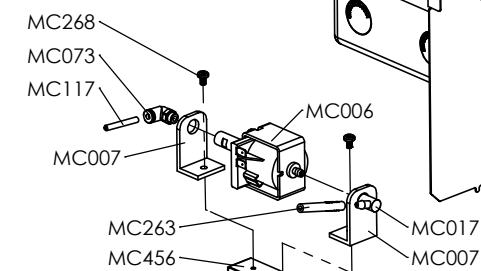
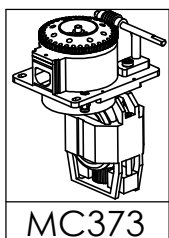
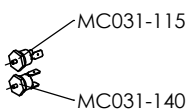
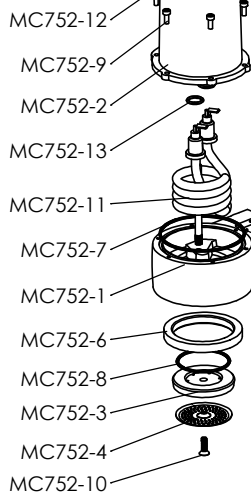
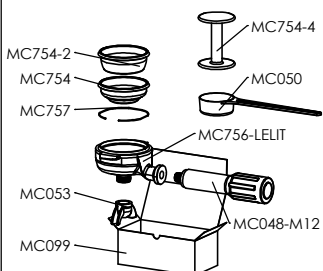
**MC752****XMC020-LELIT**

Data:	DESCRIZIONE REVISIONE

N.Disegno-CODICE: **PL042plus**

Materiale :

Descrizione : **MACCHINA CAFFE' INOX CON MACINACAFFE' CALDAIA PLUS**Disegnato : **EPIS MAURO**

Peso :

Note :

Data: **20-09-2013**

Revisione :

**LELIT**  
An important choice

Controllato:

Trattamento-finitura :

TOLLERANZE: VEDERE TABELLA UNI-EN-22768-1 m

**A4**

QUESTO DISEGNO DI PROPRIETA' AZIENDALE NON PUO' ESSERE TRASMESSO, RIPRODOTTO O RESO NOTO A TERZI SENZA L'AUTORIZZAZIONE SCRITTA DELLA PROPRIETA'